

YEv3

TechBook

in.ye-V3

optimize your customers' spa experience
with Gecko's new generation of in.ye control systems



a lot more to offer

relaxation in full colors with in.mix integration

installation made simple



Table of contents

Warnings	2
Introduction	3
Features	4
Overview	
- in.ye overview	5
- in.ye dimensions	5
Installation	
- Floor installation procedure	6
- Wall installation procedure with optional wall mounting brackets (option 1)	7
- Wall installation procedure with optional wall mounting brackets (option 2)	8
- Keypad installation	8
Connections	
- Connection of main keypad	9
- heat.wav water heater connections	10
- Connecting high voltage accessories: all models	11
- Connecting high voltage accessories: North American model in.ye	11
- Connecting high voltage accessories: European model in.ye	12
- AMP output connectors and typical accessories	13
- Completing the installation	14
Wiring	
- AMP connector and housing	15
Electrical wiring	
- Electrical wiring: all models	16
- Electrical wiring: North American model in.ye	17
- Electrical wiring: European model in.ye	18
Controler power up	19
Compatible keypads	20
Troubleshooting	21
Specifications	22

Warnings



WARNINGS:

Before installing or connecting the unit, please read the following.

-
- * FOR UNITS FOR USE IN OTHER THAN SINGLE-FAMILY DWELLINGS, A CLEARLY LABELED EMERGENCY SWITCH SHALL BE PROVIDED AS PART OF THE INSTALLATION. THE SWITCH SHALL BE READILY ACCESSIBLE TO THE OCCUPANTS AND SHALL BE INSTALLED AT LEAST 5' (1.52 M) AWAY, ADJACENT TO, AND WITHIN SIGHT OF THE UNIT.
 - * ANY DAMAGED CABLE MUST BE IMMEDIATELY REPLACED BY QUALIFIED PERSONNEL.
 - * TURN POWER OFF BEFORE SERVICING OR MODIFYING ANY CABLE CONNECTIONS IN THIS UNIT.
 - * TO PREVENT ELECTRIC SHOCK HAZARD AND/OR WATER DAMAGE TO THIS CONTROL, ALL UNUSED BUSHING CONDUITS MUST BE PLUGGED WITH THE ATTACHED NIPPLE.
 - * THIS CONTROLLER MUST NOT BE INSTALLED IN PROXIMITY OF HIGHLY FLAMMABLE MATERIALS.
 - * LOW SUPPLY VOLTAGE OR IMPROPER WIRING MAY CAUSE DAMAGE TO THIS CONTROL SYSTEM. READ AND FOLLOW ALL WIRING INSTRUCTIONS WHEN CONNECTING TO POWER SUPPLY.
 - * THIS PACK CONTAINS NO USER SERVICEABLE PARTS. CONTACT AN AUTHORIZED SERVICE CENTER FOR SERVICE.
 - * ALL CONNECTIONS MUST BE MADE BY A QUALIFIED ELECTRICIAN IN ACCORDANCE WITH THE NATIONAL ELECTRICAL CODE AND ANY STATE, PROVINCIAL OR LOCAL ELECTRICAL CODE IN EFFECT AT THE TIME OF THE INSTALLATION.
 - * PRODUCT MUST BE DISPOSED OF SEPARATELY IN ACCORDANCE WITH LOCAL WASTE DISPOSAL LEGISLATION.
 - * THIS APPLIANCE IS NOT INTENDED FOR USE BY PERSONS (INCLUDING CHILDREN) WITH REDUCED PHYSICAL, SENSORY OR MENTAL CAPABILITIES, OR LACK OF EXPERIENCE AND KNOWLEDGE, UNLESS THEY HAVE BEEN GIVEN SUPERVISION OR INSTRUCTION CONCERNING USE OF THE APPLIANCE BY A PERSON RESPONSIBLE FOR THEIR SAFETY.
 - * CHILDREN SHOULD BE SUPERVISED TO ENSURE THAT THEY DO NOT PLAY WITH THE APPLIANCE.
 - * MEANS FOR DISCONNECTION MUST BE INCORPORATED IN THE FIXED WIRING IN ACCORDANCE WITH THE WIRING RULES.
 - * CAUTION: IN ORDER TO AVOID A HAZARD DUE TO INADVERTENT RESETTING OF THE THERMAL CUT-OUT, THIS APPLIANCE MUST NOT BE SUPPLIED THROUGH AN EXTERNAL SWITCHING DEVICE, SUCH AS A TIMER, OR CONNECTED TO A CIRCUIT THAT IS REGULARLY SWITCHED ON AND OFF BY THE UTILITY.
 - * PARTS CONTAINING LIVE PARTS, EXCEPT PARTS SUPPLIED WITH SAFETY EXTRA-LOW VOLTAGE NOT EXCEEDING 12 V, MUST BE INACCESSIBLE TO A PERSON IN THE BATH OR SPA.
 - * PARTS INCORPORATING ELECTRICAL COMPONENTS, EXCEPT REMOTE CONTROL DEVICES, MUST BE LOCATED OR FIXED SO THAT THEY CANNOT FALL INTO THE BATH OR SPA.
 - * PARTS ARE TO BE INSTALLED IN THE CORRECT ZONE AND EQUIPOTENTIAL BONDING CARRIED-OUT IN ACCORDANCE WITH THE WIRING RULES.
 - * CLEARANCE AND MINIMUM DISTANCE BETWEEN THE VARIOUS PARTS OF THE APPLIANCE AND THE SURROUNDING STRUCTURE ARE NOT SPECIFIED AS LONG AS THEY ARE SUFFICIENT SO THAT THE AMBIENT TEMPERATURE AROUND THE CONTROLLER DOES NOT EXCEED 60°C.

Gecko®, and their respective logos are Registered Trademarks of Gecko Alliance Group. in.ye™, in.touch™, in.claw™, in.port™, in.flo™, in.put™, in.seal™, in.link™, in.t.cip™, in.stik™, in.k300™, in.k330™, in.k450™, in.k1000™, in.k1000+™, in.k1001™, in.k1001+™, in.k800™, in.k500™, heat.wav™, and their respective logos are Trademarks of Gecko Alliance Group.

All other product or company names that may be mentioned in this publication are tradenames, trademarks or registered trademarks of their respective owners.

Introduction



in.ye-V3

optimize your customers' spa experience with Gecko's new generation of in.ye control systems

A lot more to offer

After upgrading its smaller brother, we could not resist doing the same with Gecko's in.ye. With its boosted CPU, external memory and higher capacity relays, in.ye-V3 now has the power it needs for new features... like LED lights for troubleshooting clues. We've also added a pathway to connected accessories with faster communication, not only to open up the in.ye-V3 to the network of connected objects but to be updatable wirelessly, a definite plus for our OEM customers.

Relaxation in full colors with in.mix integration

With a light output capacity increased to 1.3A and the integration of the in.mix 300 color system on the main board, new in.lu.me cables and LED lights can be connected directly to the in.ye-V3 box with full color control directly from the keypad.

Installation made simple

With its new terminal block, onboard AMP connectors and an evolved cable strain relief system, it has never been easier to connect your accessories to a control box!

Features

The in.ye systems boast a long list of technical features. Each of them contributes to bringing the most advanced solutions available to in.ye equipped spa owners:



in.claw
advanced cable clamp system

The in.claw is an easy-to-use, modular cable clamp system that doesn't require any tool. It provides the possibility to connect up to eight high-voltage cables.



in.port
communication port

The in.port is the future of communication inside a spa! The in.ye-V3 is fully compatible with all keypads and accessories.



in.seal
watertight protection

in.seal provides an extra level of protection against water infiltration. Connectors and power box are designed to be watertight (IPX5).



in.link
ingenious plugs and connectors

The in.ye is compatible with the low-voltage family of in.link connectors, such as those used by keypads and similar low-voltage accessories.



in.stik
automated software upload

The in.stik is a pen drive with an in.link connector very similar to a USB memory stick. It connects to the spa pack and contains data to program or configure its system. The system executes the data upload automatically.



in.t.cip
water temperature algorithm

in.t.cip is an intelligent water temperature refresh algorithm that calculates optimal time to start pumps and get water temperature readings. in.t.cip continuously readjusts the heater start time (according to exterior temperature).



in.touch 2
you're always in touch with your relaxation

All in.ye packs support the in.touch internet interface, allowing you to use your favorite iOS or Android device to communicate with your spa.



in.flo
dry-fire protection

in.flo is an all-electronic dry-fire protection. The in.flo eliminates the burden of adjustments, calibrations and failures associated to usual water flow sensors.



in.put
input terminal block

in.put was designed to ease wire insertion (up to # 4 AWG) and connections. Tighter input connection reduces heat generated for increased component lifetime.

Overview

in.ye overview

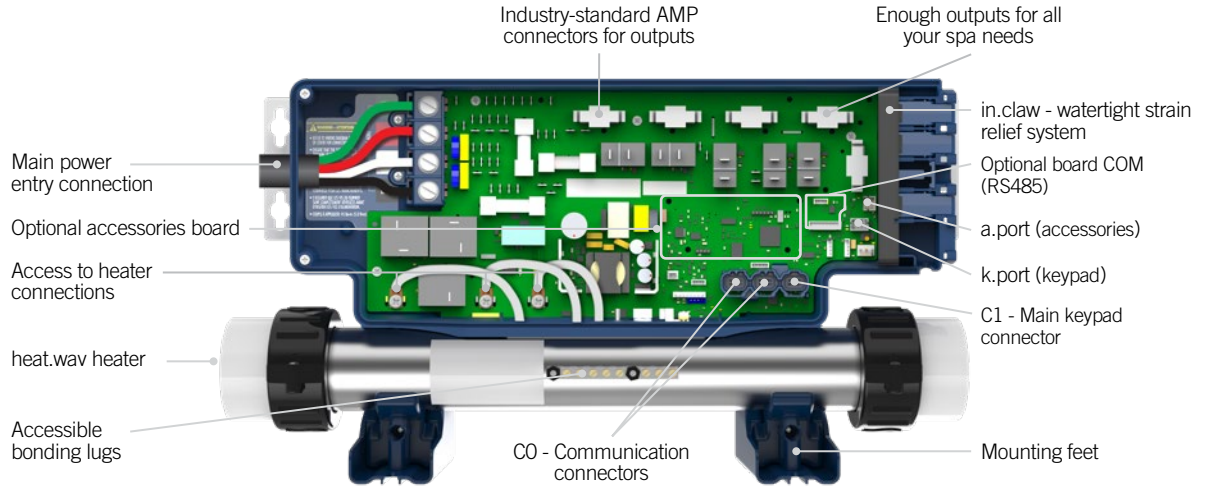

in.ye dimensions

Front view

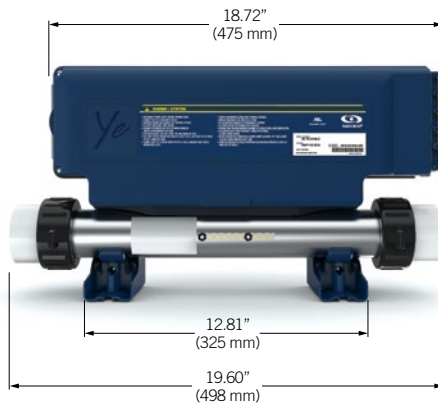

Side view

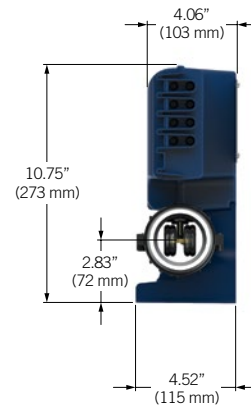

Rear view

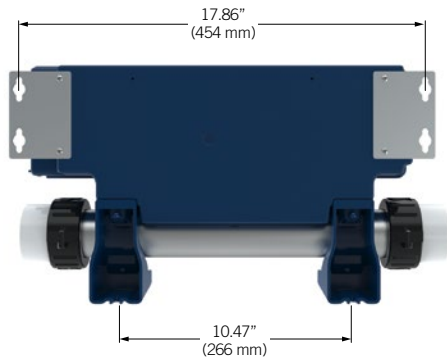

Bottom view

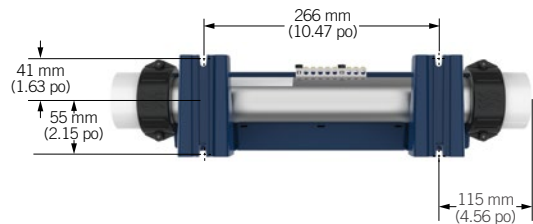

Note: Shown with optional wall mounting brackets (see Installation).

Installation

Important! Read before starting:

Please note that countersunk screws should not be used as they can damage the power box support.

The heat.wav heating element must be installed in the return circuit of the main pump (pressure side).



Warning!

Beware of the application of some products commonly used against corrosion (such as WD-40 family products) as they could damage the pack, due to a negative chemical reaction between some industrial oils and its plastic enclosure. Any other materials which may come in contact with the enclosure must be carefully evaluated under end use conditions for compatibility.



Note: The spa pack must be installed at least 4" (100 mm) above potential flood level. If floor is on ground level, pack should be raised at least 4" (100 mm).

Floor installation procedure

The following material is recommended:

- 4- # 10 screws of appropriate length with round, truss or pan head.
- 4- washers .5 OD» x .0625» thickness (12 mm OD x 1.5 mm)



Select the most appropriate location on the floor for the spa pack and firmly attach the 2 rear feet to the wooden base using 2 screws backed by 2 washers.



Now firmly attach the front feet of the pack to the wooden floor using 2 more screws backed by 2 washers.

Installation

Wall installation procedure with optional wall mounting brackets (option 1)



Install mounting brackets on both sides of the rear of the unit, using screws provided with bracket.

Torque screws to 13 in. lb max (1.49 N.m).

The following material is recommended:

4- # 10 screws of appropriate length with round, truss or pan head.

4- washers .5 OD» x .0625» thickness (12 mm OD x 1.5 mm)



Use 2 standard 2" x 4" or 2" x 6" wall studs, spaced 17-inch from center to center to fix the spa pack.

Firmly attach, one at a time, upper mounting holes on each side of the spa pack with 2 screws backed by 2 washers.

Firmly attach lower mounting holes on each side of the pack with the 2 remaining screws and 2 washers.

Lower mounting holes are 2" (51 mm) below upper holes.

Part number: Wall mount bracket kit 100 pcs - 9920-101474 (with 200 screws to attach to pack)

Installation

Wall installation procedure with optional wall mounting brackets (option 2)



Install mounting brackets on both sides on the top at the rear, using screws provided with bracket.
Torque screws to 13 in. lb max (1.49 N.m).

Use 2 standard 2" x 4" or 2" x 6" wall studs, spaced 17-inch from center to center to fix the spa pack.

Firmly attach, one at a time, external mounting holes on each side of the spa pack with 2 screws backed by 2 washers.

Firmly attach internal mounting holes on each side of the pack with the 2 remaining screws and 2 washers.

Internal and external holes are distant from 2" (51 mm) on the mounting bracket.

Part number: Wall mount bracket kit 100 pcs - 9920-101474 (with 200 screws to attach to pack)

The following material is recommended:

- 4- # 10 screws of appropriate length with round, truss or pan head.
- 4- washers .5 OD» x .0625» thickness (12 mm OD x 1.5 mm)

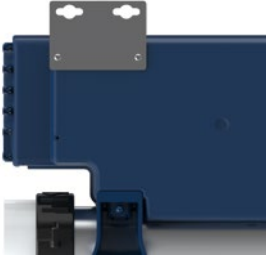

Keypad installation

For detailed instructions and drilling template, refer to the [compatible keypad](#) section and select your keypad to be redirected to the corresponding techbook.

Connections

Connection of main keypad

Note: always shut power down before connecting an accessory to the in.ye.

To connect the keypad, remove the cover, then insert the in.link connector into the appropriate keypad connector (as illustrated). Route the cable through one of the molded strain relief channels on the bottom right side of the spa pack (as illustrated). Fill the remaining space with the foam gaskets supplied. Don't forget to replace the cover and all screws (torque to 8 in. lb max (0.9 N.m)).

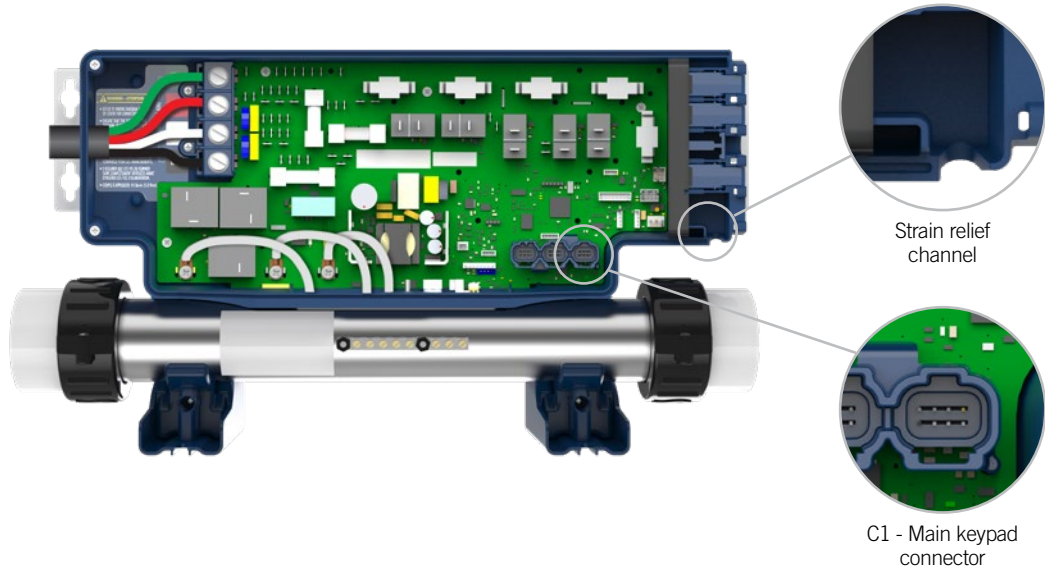

Connections

heat.wav water heater connections

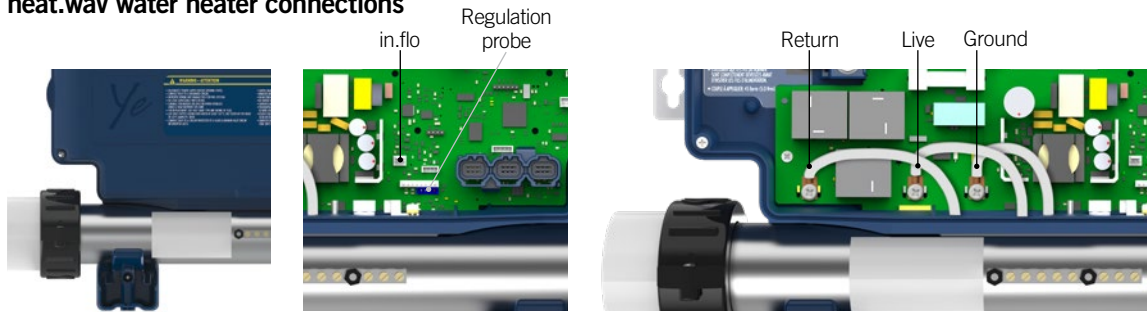

in.ye systems come with a high performance heat.wav heater. With no pressure switch, it features in.flo integrated dry-fire protection.

The heat.wav heater is factory configured for 240 V / 4 kW, but it can be converted to a dedicated 120 V / 1 kW by simply adding a cable connection. (120 V conversion is available on North American in.ye-3 models only).

The heat.wav heater is also offered in 240 V / 5,5 kW or 240 V / 2 kW versions.

heat.wav specification summary:

- Supports 120 V or 240 V
- Incoloy® heater element
- Protected by external breaker (not fused)*

**Note : European models are 230-240 V only and are fuse protected.*

Part numbers:
 9917-101959 (cable for conversion)
 9920-101449 (5.5 kW heat.wav heater)

All heater connections are accessible when the cover is removed. These previously mentioned connections are installed from manufacturing and must not be removed. Connections include the in.flo dry-fire protection, hi-limit/regulation probe connectors, power and ground cable connections.

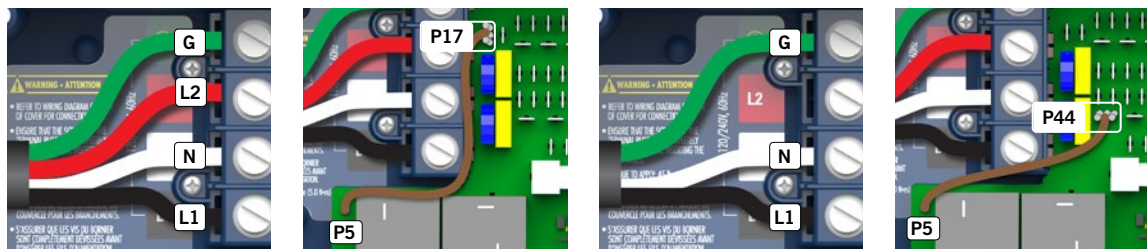

Connections for 240 V heaters (North American installations only)

BROWN wire must be correctly connected between P5 and P17.

Connections for 120 V heaters (1 kW)

BROWN wire must be correctly connected between P5 and P44.

Note: To convert model to a 120 V system, whites cables from the AMP connectors and from all accessories must be shunted. See wiring diagram for details.

Connections

Connecting high voltage accessories: all models

Two options are available with Y Series spa packs for connecting high voltage accessories: 0.250" quick-connect terminals, or AMP connectors conform to industry standards.

Connecting high voltage accessories: North American model in.ye

For the connection to the 0.250 inch terminals, the high voltage accessories must be provided with female quick connect terminals, straight and non-insulated for all types of connections, including the ground. Accessories of 120 V or 240 V may be connected to the corresponding terminals of the printed circuit of the in.ye. Refer to the following tables for correct connections. Note that all female terminals must be correctly and completely seated on the printed circuit terminals for proper current ratings.

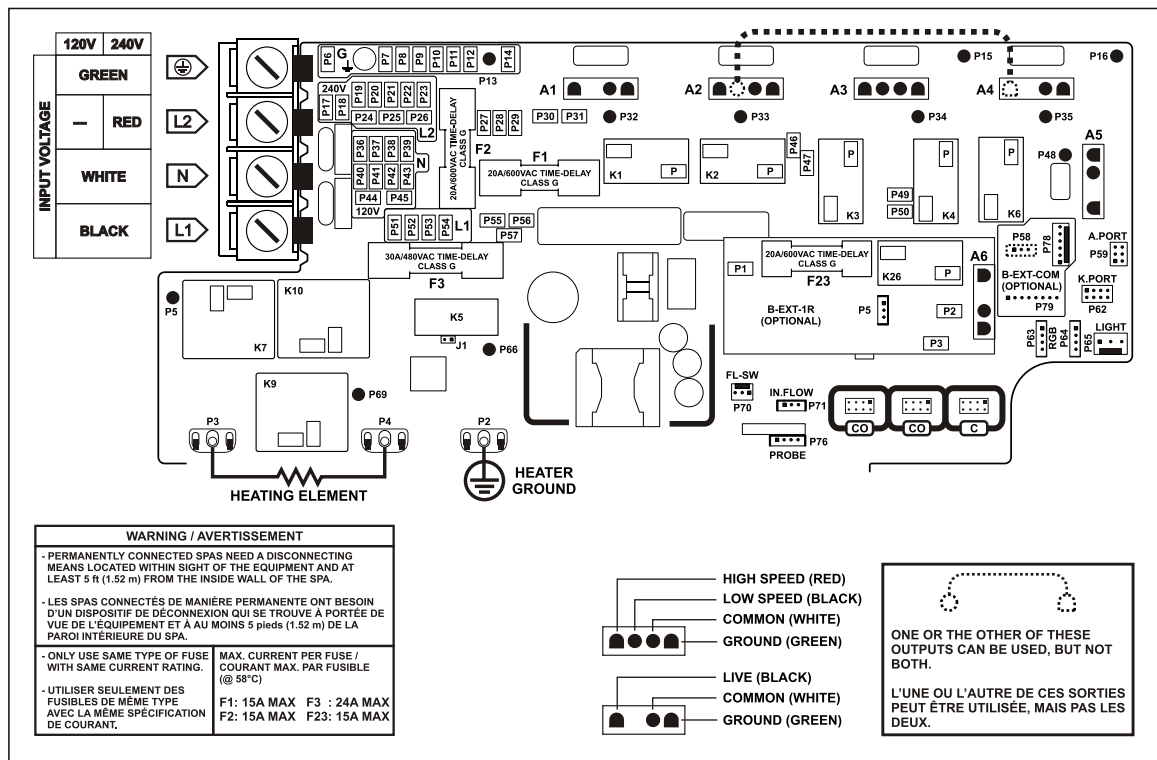

Connection for model without AMP connectors:

Direct output 1 (A5)		Pump 1 (A3)		Pump 2 (A2) (in.ye-5 only)		Pump 3 (A4) (in.ye-5 only)	
Voltage	120 V 240 V	Voltage	120 V 240 V	Voltage	120 V 240 V	Voltage	120 V 240 V
Green / ground	P11 P11	Green / ground	P8 P8	Green / ground	P8 P8	Green / ground	P10 P10
Black / line	P49 P49	Black / low speed	K2-P K2-P	Black / low speed	K6-P K6-P	Black / line	K6-P K6-P
White / common	P44 P24	Red / high speed	K4-P K4-P	Red / high speed	K3-P K3-P	White / common	P39 P22
		White / common	P38 P21	White / common	P37 P20		
Optional output (A26) (in.ye-4 or -6 only)		Circulation pump* (A1)		Pump 2 (A2) (in.ye-3 only)		Light (12 V dc, 1.3 A Max.)**	
Voltage	120 V 240 V	Voltage	120 V 240 V	Voltage	120 V 240 V		
Green / ground	P12 P12	Green / ground	P7 P7	Green / ground	P8 P8	P65	
Black / line	K26-P K26-P	Black / line	K1-P K1-P	Black / low speed	K2-P K2-P	LEDs RGB (in.lu.me only)	
White / common	P45 P26	White / common	P36 P19	White / common	P37 P20	P63; P64	

* Ozonator and circulation pump can be combined on the same output via the optional splitter PP1.

** Max. available current for Light and LEDs RGB together.

This table shows typical connections. OEMs may have a different connection scheme.

Connections

Connecting high voltage accessories: European model in.ye

For the connection to the 0.250 inch terminals, the high voltage accessories must be provided with female quick connect terminals, straight and non-insulated for all types of connections, including the ground. Only 230 V accessories may be connected to the corresponding terminals of the printed circuit of the in.ye. Refer to the following tables for correct connections. Note that all female terminals must be correctly and completely seated on the printed circuit terminals for proper current ratings.

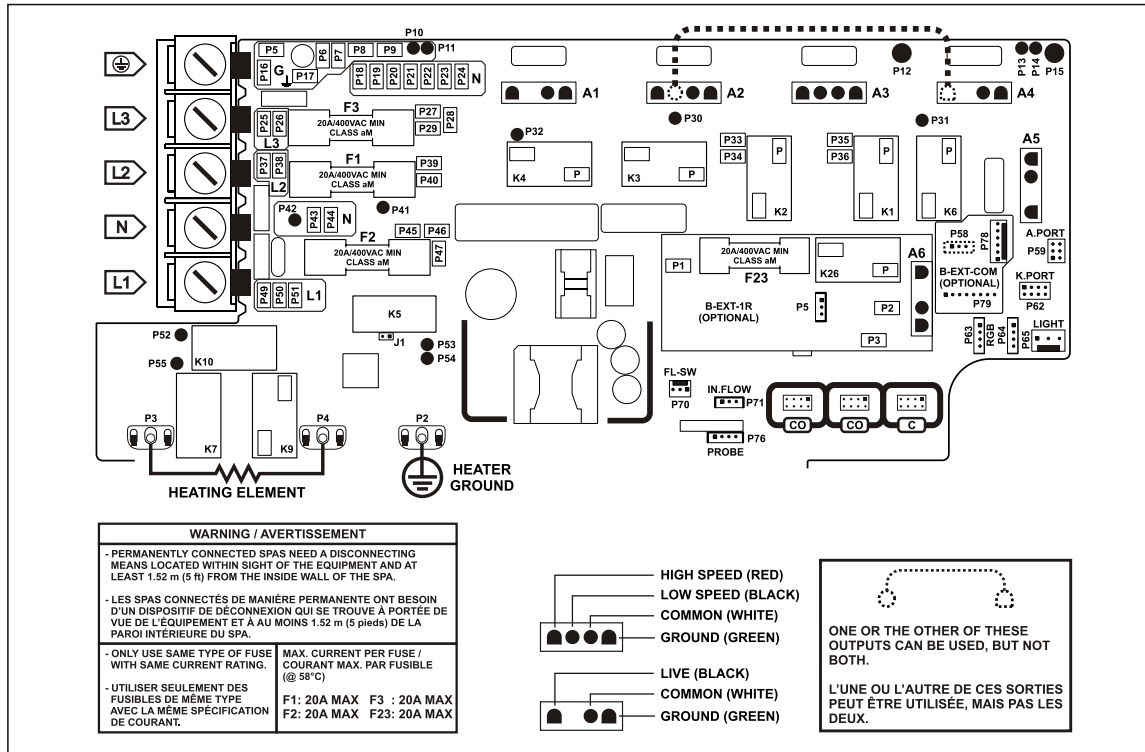

Connection for model without AMP connectors:

Direct output 1 (A5)	Pump 1 (A3)	Pump 1 (A2) (in.ye-5-CE)	Pump 3 (A4) (in.ye-5-CE only)
Voltage	Voltage	Voltage	Voltage
Green / ground P16	Green / ground P8	Green / ground P7	Green / ground P9
Black / line P45	Black / low speed K2-P	Black / low speed K6-P	Black / line K6-P
White / common P22	Red / high speed K1-P	Red / high speed K3-P	White / common P21
	White / common P20	White / common P19	

Pump 2 (A2) (in.ye-3-CE)	Circulation pump* (A1)	Light (12 V dc, 1.3 A Max.)**	Optional output (A26) (in.ye-4-CE or -6-CE only)
Voltage	Voltage	Voltage	Voltage
Green / ground P7	Green / ground P6	P65	Green / ground P17
Black / low speed K2-P	Black / line K4-P	LEDs RGB (in.lu.me only)	Black / line K26-P
White / common P19	White / common P18	P63; P64	White / common P44

* Ozonator and circulation pump can be combined on the same output via the optional splitter PP1.

** Max. available current for Light and LEDs RGB together.

This table shows typical connections. OEMs may have a different connection scheme.

Connections

AMP output connectors and typical accessories

Outputs illustrated below are typical accessories for AMP connectors. These configurations may change depending on your control system. For more information, please refer to the wiring diagram on the casing cover.

in.ye-30P

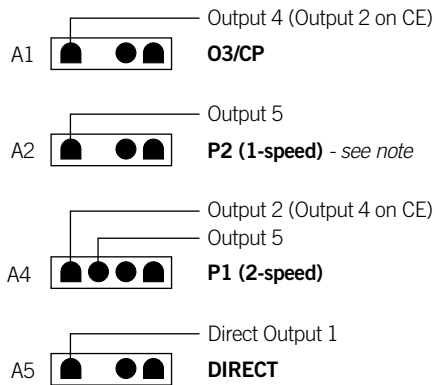
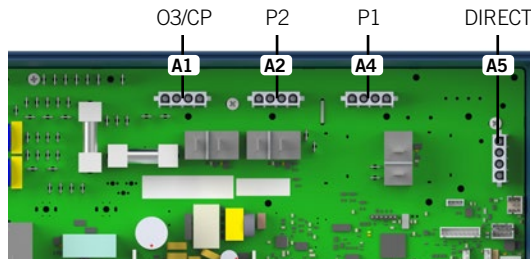

Note: If P2 is used, P1L cannot be used.

in.ye-50P

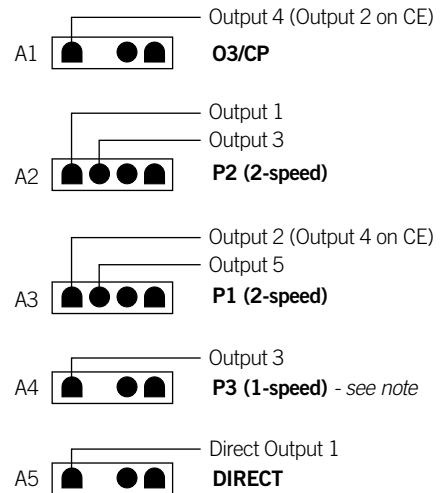
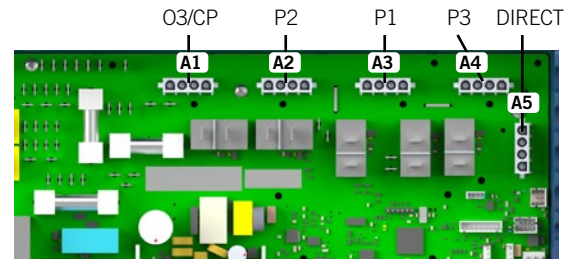

Note: If P3 is used, P2L cannot be used.

Option EXT-1R

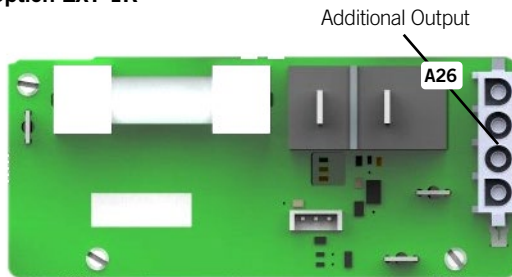

Optional output available. Could be ordered directly as in.ye-40P or in.ye-60P, or separately

Part number:
0610-100005 - extension board for additional output

Contact your account manager for more details.

Option EXT-COM

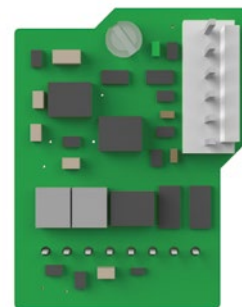

Optional extension communication board for in.temp support. Could be ordered directly as an option of your in.ye or separately

Part number:
0610-100006 - extension communication board for in.temp support

Connections

Completing the installation



Once all cables of high voltage accessories are connected and routed to the right openings, remove the empty in.claw from the enclosure.



Open the in.claw and place the wire inside in the middle of the round shape form.

Each in.claw can take up to 2 high voltage cables, (OD 0.410" (10.41 mm) max. - OD 0.300" (7.62mm) min.).

Make sure that the cable jacket exceeds the in.claw foam inside the in.ye.



Close the in.claw on the wire.



Reinsert the in.claw in its original position, pressing down on either side of the cable.



Close off unused opening in the enclosure with the shut-off.

Note: By default, in.ye-30P has 2 in.claws and 2 shut-off
in.ye-50P has 3 in.claws and 1 shut-off

Part Numbers:
9920-102288 - in.claw
9917-106808 - shut-off

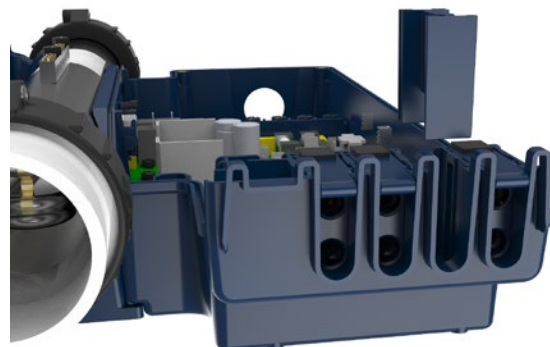

Once all in.claw's and shut-off are reinserted, replace the cover. Cover screws should be tightened to a max of 8 lb.in (0.9 N.m).

Wiring

AMP connector and housing

A special PP-1 splitter can be ordered (Part #: 9920-401369) and used to split an output into 2 parallel outputs (i.e. a single output could be used to drive two accessories like an ozonator and a UV generator, or a CP). Both accessories driven must be of the same operating voltage (120 V or 240 V).

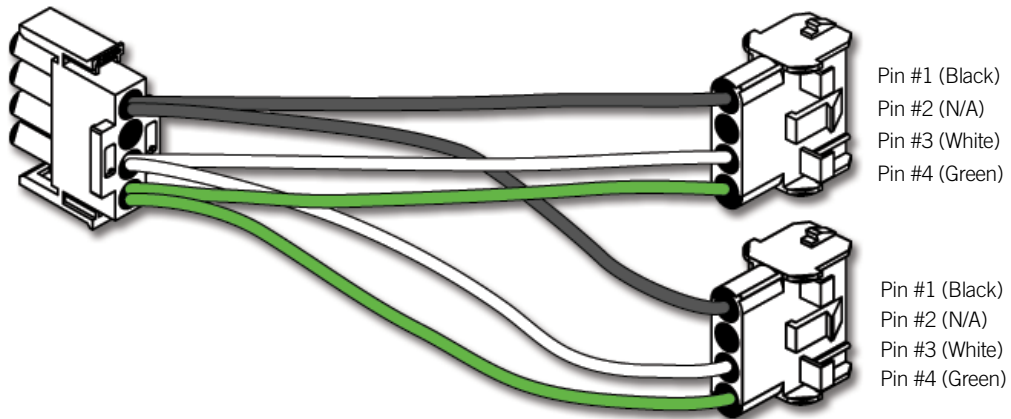

Electrical wiring

Electrical wiring: all models

Warning
 Disconnect power before starting electrical work. Wiring must be completed by a qualified electrician and must be done in accordance with the local electrical code.

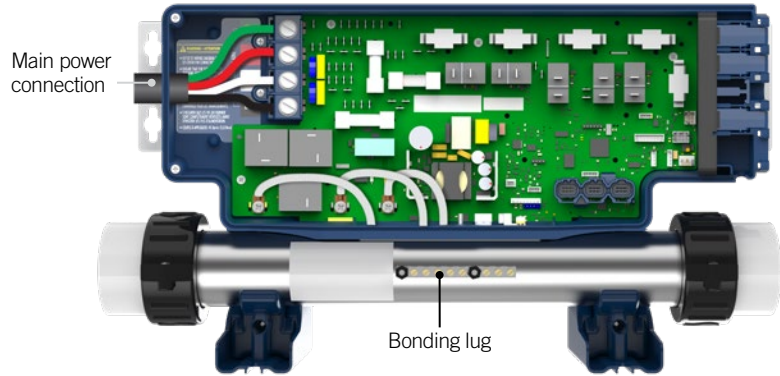

To complete the electrical connections of our in.ye control system you will need a Phillips screwdriver and a flat-head screwdriver (slotted head size between 5/16" and 3/8").

Remove the screws from the system control lid and remove it.

Remove 5 1/2" (142 mm) of cable insulation.

Strip away 1" (25 mm) of insulation from each wire.

Pull the cable through the cutout of the box and secure it with a NPT strain relief* (hole diameter 1,335" [34,42 mm]). Ensure that the NPT strain relief clamps around the outer sheath of the cable.

** For CE use an IEC certified plastic bushing that will maintain the IPX5 rating.*

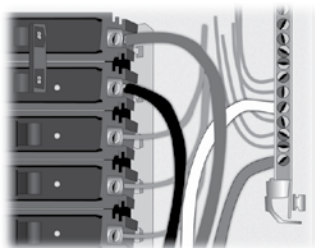
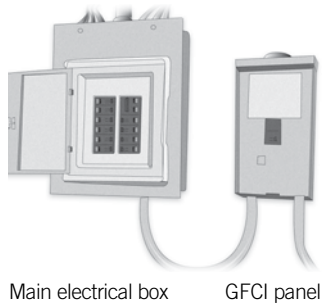

Warning

For units for use in other than single-family dwellings, a clearly labeled emergency switch shall be provided as part of the installation. The switch shall be readily accessible to the occupants and shall be installed at least 5' (1.52 m) away, adjacent to, and within sight of the unit.

This product must always be connected to a circuit protected by a ground fault interrupter.

Proper wiring of the electrical service box, GFCI and in.ye terminal block is essential!

Check your electrical code for local regulations. Only copper wire should be used, never aluminum.

Disposal of the product

The appliance (or the product) must be disposed of separately in accordance with the local waste disposal legislation in force.

Electrical wiring

Electrical wiring: North American model in.ye

Refer to wiring diagram in the enclosure box lid for more information.

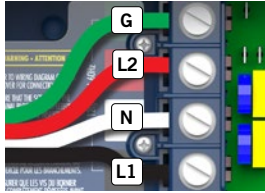

240 V (4 wires)

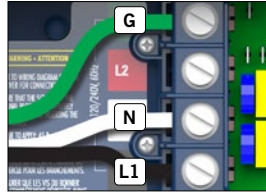

120 V (*3 wires)

* If connected to a 3 wires system, the heat.wave and accessories will not operate at 240 V.

Note: To convert model to a 120 V system, whites cables from the AMP connectors and from all accessories must be shunted. See wiring diagram for details.

Refer to the section
« Connections for 120 V
heaters ».

Insert each wire into the appropriate socket of the main entry terminal block according to the color code indicated on the sticker. Use a flat-head screwdriver to tighten the screws on the terminal (please refer to the sticker inside the casing to see the torque to apply).

After making sure wires are securely connected, push them back into the box and replace the cover. Do not over tighten cover screws (torque to 8 in. lb max {0.9 N.m}).

Connect the bonding conductor to the bonding lug on the front of the spa pack (a grounded electrode conductor should be used to connect the equipment grounding conductors).

Electrical wiring

Electrical wiring: European model in.ye

Refer to wiring diagram in the enclosure box lid for more information.



Warning

in.ye.ce models must always be connected to a circuit protected by a Residual-Current Device (RCD) having a rated operating residual-current not exceeding 30 mA.

Correct wiring of the electrical service box, RCD, and pack terminal block is essential! Check your electrical code for local regulations. Only copper wire should be used, never aluminum.

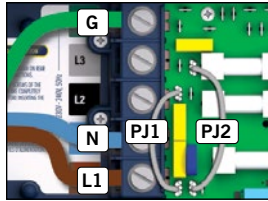

1-phase

Connect PJ1 between P37 and P49.

Connect PJ2 between P50 and P26.

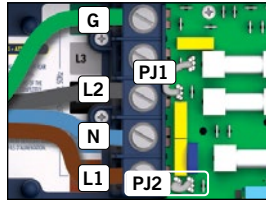

2-phase

Connect PJ1 between P37 and P26.

Connect PJ2 between P50 and P49.

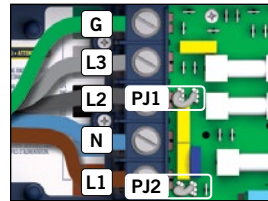

3-phase with single neutral

Connect PJ1 between P37 and P38.

Connect PJ2 between P50 and P49.

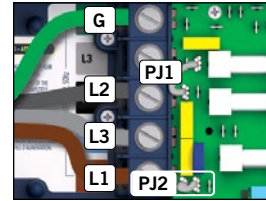

3-phase Delta (no neutral)

Connect PJ1 between P37 and P26.

Connect PJ2 between P50 and P49.

input voltage: 230V, 50Hz (Line-to-Neutral)

Only for countries where Line-to-Line input voltage: 230V, 50Hz.

Insert each wire into the appropriate socket of the main entry terminal block according to the color code indicated on the sticker. Use a flat-head screwdriver to tighten the screws on the terminal (please refer to the sticker inside the casing to see the torque to apply).

After making sure wires are securely connected, push them back into the box and replace the cover. Do not over tighten cover screws (torque to 8 in. lb max {0.9 N.m}).

Connect the bonding conductor to the bonding lug on the front of the spa pack (a grounded electrode conductor should be used to connect the equipment grounding conductors). Bonding conductor must meet local electrical code.

Controller power up

Start up of your control system

To perform the control system start up, refer to the manual:
[Start up guide and basic configuration](#)



Compatible keypads

List of compatible keypads for the in.ye control system

For more information on the compatible keypads for your control system refer to the corresponding Techbook.



[in.k300 main keypad](#)
LCD display, 4 keys



[in.k330 main keypad](#)
Color LCD display, 5 keys



[in.k450 main keypad](#)
ACL display, 7 keys



[in.k500 main keypad](#)
Color LCD display, 7 keys



[in.k800 main keypad](#)
Color LCD display, 10 keys



[in.k1000 main keypad](#)
[in.k1000+ main keypad](#)
Color LCD capacitive
touchscreen display



[in.k1001 main keypad](#)
[in.k1001+ main keypad](#)
Color LCD capacitive
touchscreen display

Troubleshooting

Troubleshooting information for your control system

You come across a problem with your control system, for the troubleshooting of your control system, refer to the manual: [Troubleshooting guide](#)





Specifications

Environmental ratings

Operating temperature:	32°F (0°C) to 136°F (58°C)
Storage temperature:	-13°F (-25°C) to 185°F (85°C)
Humidity:	Up to 85% RH, non condensing
Level of waterproofing:	IPX5

Mechanical

in.ye

Weight:	7.7 lb (3.5kg)
Dimensions (W x H x D):	19.60" x 10.75" x 4.52" (498 mm x 273 mm x 115 mm)

Specifications

in.ye North American electrical specifications

Input rating: 120/240 V nominal (+5/-10 %)
60 Hz, (2 lines required with neutral) 48 A max.

or (in.ye-3 only): 120 V nominal only (+5/-10 %)
60 Hz, (single line with neutral) 16 A max.

Heat.wav rating:

Voltage: 120 V or 240 V, 60 Hz

Wattage: 5,5 kW at 240 V, 4 kW at 240 V or 1 kW at 120 V

Flow rate: Minimum of 18 GPM (68 LPM) is required

Output	Voltage	Maximum current	Typical Device	ye-3*	ye-5
Output 1	120 or 240 V	15 FLA/60 LRA (inrush)	Pump 2 high speed		●
Output 2	120 or 240 V	15 FLA/60 LRA (inrush)	Pump 1 high speed	●	●
Output 3	120 or 240 V	15 FLA/60 LRA (inrush)	Pump 2 low speed		●
Output 4	120 or 240 V	15 FLA/60 LRA (inrush)	Ozonator	●	●
Output 5	120 or 240 V	15 FLA/60 LRA (inrush)	Pump 1 low speed	●	●
Output 6	120 or 240 V	15 FLA/60 LRA (inrush)	Pump 3 (4) high speed	optional	optional
Direct out 1	120 or 240 V	5 A	Audio/video	●	●

Important:

The maximum current for output 2 and Direct 1 on fuse F1 may not exceed 15 A.
The maximum current for outputs 4, 5 on fuse F2 may not exceed 15 A.
The maximum current for outputs 1 and 3 on fuse F3 may not exceed 20 A.
The maximum current for outputs 6 on fuse F23 may not exceed 15 A.

* This model can be converted to a dedicated 120 V model.

UL/CSA Standards

UL 1563 Sixth Ed. (2012) (rev date 2017)
UL File: E182156
CAN/CSA C22.2 No. 218.1-13 (2013) (Ed. 2 - rev date 2016)



Specifications

in.ye European electrical specifications:

Input rating: 230/240 V nominal (+5/-10 %)
50 Hz, (3 lines required with neutral), three-phased system 16 A Max per phase.

or 230/240 V nominal (+5/-10 %)
50 Hz, (2 lines required with neutral), dual-phase system 20 A Max per phase.

or 230/240 V nominal (+5/-10 %)
50 Hz, (1 line required with neutral), single-phase system 48 A max.

heat.wav rating:

Voltage: 230/240 V, 50 Hz
Wattage: 3,8 kW at 230 V or 2,8 kW at 230 V
Flow rate: A minimum of 18 GPM (68,1 LPM) is required

Output	Voltage	Maximum current	Typical Device	ye-3	ye-5
Output 1	230/240 V	15 FLA/60 LRA (in-rush)	Pump 2 high speed		●
Output 2	230/240 V	15 FLA/60 LRA (in-rush)	Ozonator	●	●
Output 3	230/240 V	15 FLA/60 LRA (in-rush)	Pump 2 low speed		●
Output 4	230/240 V	15 FLA/60 LRA (in-rush)	Pump 1 high speed	●	●
Output 5	230/240 V	15 FLA/60 LRA (in-rush)	Pump 1 low speed	●	●
Output 6	230/240 V	15 FLA/60 LRA (in-rushl)	Pump 3 (4) high speed	optional	optional
Direct out 1	230/240 V	5 A	Audio/video	●	●

Important:

The maximum current for output 2 and heater output on fuse F1 may not exceed 20A.
The maximum current for outputs 4, 5 and direct 1 on fuse F2 may not exceed 20A.
The maximum current for outputs 1 and 3 on fuse F3 may not exceed 20A.
The maximum current for outputs 6 on fuse F23 may not exceed 20A.

European and international standards

IEC 60335-1 : 2010, A1 : 2013, A2 : 2016
IEC 60335-2-60 : 2017
EN 60335-2-60 : 2003, A1 : 2005, A2 : 2008, A11 : 2011, A12 : 2010
EN 60335-1 : 2012, A11 : 2014, A12 : 2017, A13 : 2017
EN 62233 : 2008

EN55014-1 (2017)
EN55014-2 (2015)

AS/NZS 60335.2.60 : 2006
AS/NZS 60335.1 : 2011, A1 : 2012, A2 : 2014, A3 : 2015, A4 : 2017

FCC part 15 (2019) subpart B
ICES-003 (2016) + update (2019)





9919-101682-A
Rev. 11-2020

© Groupe Gecko Alliance inc., 2020
All trademarks or registered trademarks
are the property of their respective owners.

Gecko Alliance
450 des Canetons, Québec (Qc), G2E 5W6 Canada, 1.800.78.GECKO
www.geckoalliance.com

Printed in Canada